

# Material problems in the three versions of chloralkali electrolysis\*

PETER KOHL, K. LOHRBERG

LURGI GmbH, Lurgiallee 5, D-6000 Frankfurt, FRG

Received 10 August 1988; revised 20 October 1988

Since the introduction of the industrial electrolytic production of chlorine and caustic from brine operators have been challenged by the corrosion problems due to the aggressive media and the potential differences across the cellroom under load. Operational conditions of the process (temperature, current density, etc.) were chosen close to the stability limits of the construction materials, where stability means feasible service lifetimes. This paper deals with some corrosion problems which are typical for the chloralkali process and which may demonstrate the close interrelationship between operational conditions and material stability.

## 1. Introduction

When asking a cellroom operator to talk about material problems in chloralkali cellrooms most likely his first response will be "Where to start, where to stop?" Chloralkali cellrooms are dealing with extremely corrosive media. In addition, the voltage differences across the cellroom cause electrochemical reactions outside the cell in the peripheral equipment, which mostly show up as corrosion processes. Even within the cell the potential differences may cause severe corrosion problems.

The main problem of the chloralkali cellroom is to find the optimum operational conditions balancing maintenance costs due to corrosion versus investment and power cost. The introduction of metal anodes, for instance, did not result in lower cell voltages, but the capacity of the cellroom was increased by nearly doubling the current density. The introduction of stainless steel and nickel in the caustic loop of membrane cellrooms instead of carbon steel lead to an increase of the electrolysis temperature up to 95°C, where steel would be corroded.

This paper gives some examples of material problems; the discussion is restricted to the cellroom itself. Therefore corrosion problems occurring at the peripheral equipment of the cellroom such as the chlorine compressors or evaporation plants will not be considered.

## 2. Stray currents

The key problem in any cellroom is stray currents flowing through the system of the electrolyte feed and discharge headers, disappearing somewhere via coolers, pumps or other earth-grounded equipment. A relatively simple example is in chlorate electrolysis.

Any combination of electrolyzers in a cellroom will inevitably lead to stray currents because of the potential difference from cell to cell. Obviously the currents are limited by the resistivity of the electrolyte path, which can be influenced by reduction of the cross section or by increasing the length of the feed or discharge pipes.

A typical chlorate cellroom is equipped with two rows of monopolar cells electrically connected in series, cross-over bus-bars are connecting both rows. Below the cells is the feed header common for all cells of the row; above the cells the corresponding collector header is located. Because of the corrosive nature of the hypochlorite/chlorate electrolyte the header as well as the cell casings are titanium. Any metallic short circuit is prevented by means of glass pipes; the electrolyte within these pipes forms the resistor which limits the stray currents. Because of the high circulation rate the cross sections of the headers and the feed tubes are far larger than in chloralkali cells.

The stability of the titanium against chemical attack by oxidizing agents is caused by a thin passive layer. This layer exhibits a wide electronic gap between the valence band and the conduction band. It restricts an anodic electron transfer almost completely (less than  $10^{-9}$  kA m<sup>-2</sup>), whereas cathodic electron transfer can occur via the conduction band. The titanium surface is acting as a diode, metals forming oxides with wide band gaps are known as valve metals. Looking at the cell adjacent to the negative pole of the rectifier, the situation can be represented by the equivalent circuit shown in Fig. 1.

The stray current flows from the cell to the titanium header, which represents the point of electrical symmetry for the entire system because all headers are metallically connected via the reaction tank. This means that for a cellroom comprising 40 cells at an

\* Paper presented at the meeting on Materials Problems and Material Sciences in Electrochemical Engineering Practice organised by the Working Party on Electrochemical Engineering of the European Federation of Chemical Engineers held at Maastricht, The Netherlands, September 17th and 18th 1987.

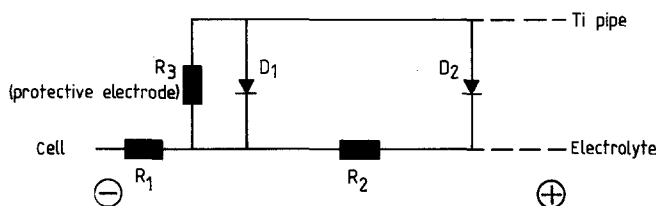

Fig. 1. Equivalent circuit for the Ti passivation layer.

operating cell voltage of 3.2 V, the voltage difference between the electrolyte in the cell under consideration and the header is 64 V and the resistance of the electrolyte is about  $2\Omega$ . This means that a stray current of maximum 32 A flows from the cell to the titanium headers, passing the cell cones and the glass tube represented by  $R_1$ . An anodic current passes through the passive layer of the titanium. Due to the properties of the passive layer, it acts as a diode in the backward direction with extremely small current densities, as outlined earlier. Consequently, the stray current is spread over a large surface area, which means a high penetration depth of the stray current into the header via the electrolyte. The electrolyte resistance here is represented by  $R_2$ . Due to the potential drop across the electrolyte the titanium exhibits a locally variable voltage difference against the adjacent electrolyte; the maximum value is reached at the titanium flange of the header, i.e. the point adjacent to the cell.

The passive layer can then be represented by diodes connected in parallel. In Fig. 1  $D_1$  represents the passive layer at the flange and  $D_2$  the layer at some distance from the flange.

If the voltage drop across  $R_2$  exceeds the breakthrough voltage of the diode, which from laboratory tests occurs at 11.5 V, the total stray current will pass the breakthrough region and the resulting current density will be high enough to prevent any annealing of the passive layer; the structure will be destroyed in a short time.

To overcome this situation, a protective anode may be installed, represented by  $R_3$ . This will reduce the maximum voltage across  $R_2$  to the cell voltage of the

production cell, because the same reactions occur. These protective anodes are concentric titanium rings which are coated in the same way as the anodes of the cell itself. The dimensions are designed to allow a lower current density at the protective anodes than that in the cells. In this way it is assured that the total stray currents pass through the protective electrodes, the lifetime of which is at least that of the cell anodes.

Due to the principle of electroneutrality, the anodic stray currents must be compensated by cathodic currents; these flow from the cell row connected to the positive pole of the rectifier to the headers. The situation is the same but the diode is now operating in the forward direction. Therefore all the stray currents flowing from the cell pass the phase boundary within a small region next to the connecting flange. The penetration depth is reduced to some centimeters. The limiting condition is overvoltage for the hydrogen evolution reaction at the flange = voltage drop across the electrolyte across  $R_2$ . The resulting high current density causes diffusion of hydrogen into the titanium structure. The formation of titanium hydride,  $TiH_x$ , where  $x$  may range from 1 to 2, causes embrittlement of the metal followed by destruction of the flanges.

In this case we make use of the small penetration depth of the stray currents. Protective titanium cathode blades are placed in front of the flange to be protected. These will be loaded by the full stray current and corroded by the mechanism described previously and must be replaced in due time.

The general idea of this corrosion protection system is not to try to reduce the stray currents but to control the flow direction; no stray currents will leave the system, no efficiency losses occur. Because of the circulation of the electrolyte it is of no importance where the chlorine to be converted to chlorate is generated. The only side condition is that the entire header system is directly connected, i.e. all extension joints and flanges must be properly bridged by copper stripes.

### Pitting corrosion of titanium

Knowing about the effects of stray currents one may conclude that titanium is not corroded when stray currents are absent. In fact, it is well known that titanium withstands the attack of wet chlorine and aqueous solutions containing chlorine.

On the other hand, it is a costly experience with many cellrooms that in narrow gaps corrosion, accompanied by  $TiO_2$ -formation, occurs. Sealing areas, but also gaps between welded titanium structures etc., are often affected by this corrosion type.

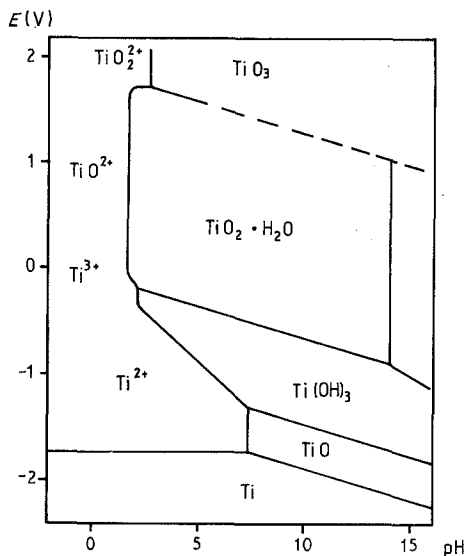
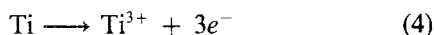
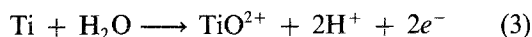
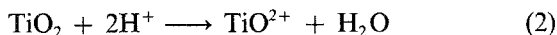
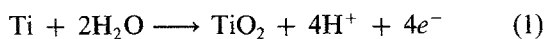

Fig. 2. Pourbaix diagram for titanium.

Sometimes it is observed that the corrosion leads to a sandwich package oxide/metal/oxide.

According to the Pourbaix diagram (Fig. 2) [1] there are four reactions describing the corrosion of titanium:



The cathodic counter reactions may be:

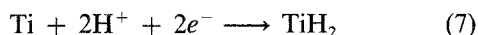
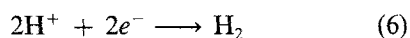
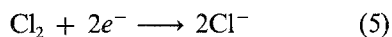

These reactions may occur in the gap or outside, where the titanium is exposed to the bulk solution. The driving force is the formation of local elements due to the locally different environment.

Since the corrosion pattern is the same as observed in the case of stray currents, it is important to establish the significance of the breakthrough voltage.

Figure 3 shows the schematic band structure model of the passive layer: assuming electronic equilibrium, the Fermi level of the metal is located some hundred mV below the lower edge of the conduction band, at the energy level of donor terms present in the passive layer.

We must differentiate between the bulk rutile structure which is often associated with the passivation of titanium and the passive layer with a typical donor concentration of  $10^{20} \text{ cm}^{-3}$ . The valence band is located approximately 3.6 eV below the conduction band, under normal polarization conditions it will not participate in electron transfer reactions.

The presence of the chlorine/chloride redox couple representing the acceptor/donor states in the electrolyte causes a bending of the band structure across the passive layer. At the phase boundary oxide/electrolyte electronic equilibrium is also established, i.e. the local Fermi level there is determined by the distribution function of the donor/acceptor states of the redox couple. Within the space charge barrier the donor terms are depleted. Any anodic process is hampered by the low number of donor states in the Helmholtz layer and by the low tunneling probability as indicated by the arrow. Any increase of the electrode potential increases the number of suitably located donor terms in the electrolyte, but the space charge barrier is broadened. Therefore, at semiconductor electrodes the anodic Tafel factors often exceed 500 mV.

Cathodic processes can easily be achieved because during cathodic polarization the Fermi level of the electrode metal is raised. The band structure across the passive layer is changed accordingly and the electron transfer occurs via donor states located directly at the oxide surface.

If we compare this band structure model and the

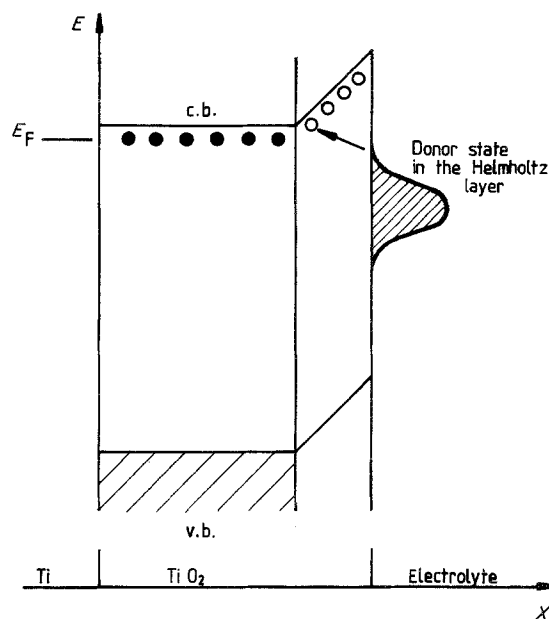

Fig. 3. Schematic representation of the band structure of passive Ti.

data available from the Pourbaix diagram with the breakthrough voltage of 11.5 V in chloride solutions [2] we conclude that the formation of pertitanium compounds is negligible. The breakthrough voltage should be limited to less than 2 V if such compounds participate in the corrosion mechanism. On the other hand, the breakthrough voltage itself depends on the anion present in the electrolyte. In sulphate solutions it is  $> 80 \text{ V}$  [3], in chloride solutions containing bromide ions only 7–8 V [4], in brine containing iodide ions about 4 V [5] and in the presence of fluoride ions less than 2 V [6]. In addition, these figures are extremely dependent on the operational conditions (electrolyte velocity, concentration of the contaminant, temperature). There is a strong interaction between the oxide and the Helmholtz layer. It is likely that Reaction 2 is influenced by the different stability of the halide complexes which may be formed in the Helmholtz layer. The same may hold true for the corrosion in narrow gaps and crevices.

Any formation or consumption of compounds in the gap, for instance the acidification by Reaction 1 or the consumption of chlorine according to the reaction 5 will cause significant concentration changes within the Helmholtz layer. The complex ions formed in the gap will be hydrolysed when they diffuse into the bulk electrolyte;  $\text{TiO}_2$  will be formed and will obscure new areas so that the process goes on.

A rough estimate, for instance for the anolyte of a membrane electrolyser ( $c = 200 \text{ g l}^{-1}$ ,  $d = 1.11 \text{ kg l}^{-1}$ ), proves that the water present in a gap 0.1 mm wide will be completely consumed for the conversion of a titanium layer only 0.03 mm thick. We must consider drastic changes of the electrolyte composition once the corrosion process is initiated.

At high field strength across the passive layer, the formation of flaws will be increased. If the formation rate exceeds the annealing rate, we get the same conditions as discussed for narrow gaps; corrosion will be

observed. Some support for this conclusion comes from cellrooms. The extremely low breakthrough voltage in the presence of  $F^-$  ions corresponds to the fact that titanium is especially sensitive to PTFE gaskets. The breakthrough voltage of 11.5 V in chloride solutions can be lowered to less than 7 V by precipitating some  $Fe(OH)_3$ .

To prevent the corrosion of titanium the oxide layer must be kept in a potential range where neither an increased annealing of the passive layer is necessary (e.g. at high potentials or due to complex formation) nor a direct dissolution according to Reaction 4 will occur because of the absence of any oxidizing compounds and the low PH of the electrolyte. It is common practice that equipment exposed to gasketing systems is protected either by use of palladium-stabilized titanium or by coatings of  $RuO_2$ .

Palladium alloys containing 0.5 or 1% Pd will dope the passive layer, thus providing suitably located donor/acceptor terms for electron transfer reactions. The potential of the titanium is limited to the potential of the redox system, in our case the chlorine or the oxygen electrode.

On the other hand, the Pd doping will catalyse the hydrogen evolution reaction to such an extent that the potential remains in the stability range of  $TiO_2$ . This also means that the corrosion due to hydride formation and subsequent embrittlement is suppressed.

The well-known catalysts for chlorine evolution, such as those based on  $RuO_2$ , will have the same effect. It is just this limitation of the anode potential which is used to stabilize the titanium equipment of the chlorate cellroom.

#### 4. Corrosion of steel frames in membrane electrolyzers

Because of its low price and its sufficient activity carbon steel is often used as cathode material in membrane cells. In order to avoid local cells the frame is also steel. Because of the different potential of the active cathode and the remote frame structure, different equilibrium concentrations of the  $[HFeO_2]^-$  ion are established. This results in a slow but steady transportation of iron from the remote structure to the cathode, where the iron is cathodically deposited. This process is so slow that the normal lifetime of the cathode frame of > 6 years is not affected. But often operators observe severe corrosion and also leakages in distinct areas.

Since the central part of the structure — the cathode — is operated in a potential range where it is cathodically protected all other parts of the steel structure which are in direct contact with the caustic must also be protected. In technical plants this means the potential must not be more anodic than the equilibrium potential related to the dissolved iron. This iron concentration is established in the peripheral equipment of the plant. If, for instance, the iron concentration is 5 ppm, the potential of any point of the cathode frame should be about 250 mV more cathodic than the

equilibrium concentration of the hydrogen electrode in the same solution. Since the cathodic overvoltage at  $3\text{ kA m}^{-2}$  is about  $-350\text{ mV}$  the voltage difference between the cathode and any steel structure of the frame must be less than 100 mV. Under these conditions we can expect that no severe corrosion will occur. Normally, the frame will be sufficiently protected if the distance to the active cathode is less than 20 cm. This figure must be reduced if hydrogen accumulation reduces the effective conductivity of the catholyte or, still worse, if there is a gas buffer formed in the upper part of the cell because of an improper design of the discharge pipe.

In various cell designs we have observed corrosion damage of the upper horizontal frame beam, mostly at the edges because of the extended distance to the cathodes, and at threads of the discharge nozzles because of the reduced cross section. It can be taken for granted that any hydrogen hold-up outside the active electrode gap will cause corrosion. Sometimes the gas zone can be traced back by the corrosion pattern. Again, the reduced cross section of the electrolyte, which sometimes is just the adherent electrolyte film at the wall, is responsible for the insufficient cathodic protection of the steel structure.

A special problem will occur if a hollow frame structure is used for internal circulation of the catholyte. The catholyte will be degassed in the upper horizontal beam, will be circulated via the vertical beams into the lower horizontal beam and enter the cathode compartment again with the feed caustic.

One can assume that the surfaces inside the vertical beams are not affected by the current passing the cathode. Like a caustic storage tank it will form a stable passive layer. On the other hand, the cathodes themselves are cathodically polarized with respect to the iron electrode. Consequently, between both regions there must be a zone where the steel is forced into the potential range of active iron dissolution. The frame structure will also be locally destroyed due to this inherent corrosion mechanism.

#### 5. Corrosion of activated steel cathode structures

Closely related to the corrosion of steel frames is the corrosion of activated steel cathodes. In principle, the same argument is valid, the lowering of the hydrogen overvoltage (the raising of the cathode potential) by some 250–300 mV is equivalent to a dramatic increase of the equilibrium concentration of the  $[HFeO_2]^-$  ion to  $10^{-2}\text{ M}$ .

According to our experience at  $3\text{ kA m}^{-2}$  and an overvoltage of 70 mV the coating flakes off the structure because the iron is dissolved at the boundary between the steel support and the catalyst layer. Meanwhile, all suppliers of activated cathodes have learned by experience this phenomenon; the number of new patent applications dealing with such electrodes has dropped to almost zero. Today cathode activations are only offered with nickel structures or nickel-plated steel structures. The risk of the latter

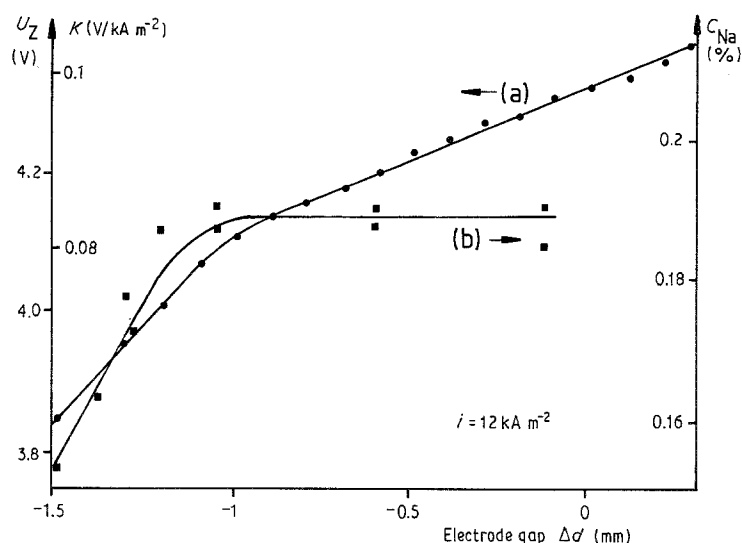

Fig. 4. Optimization of the power consumption of mercury cells: cell voltage (a) and Na content of amalgam (b) vs electrode gap. Reference  $\Delta d = 0$  corresponds to a gap of approx. 2 mm.

structures is quite clear; any single scratch may expose the iron to the caustic and the entire structure will be corroded.

Despite this conclusive mechanism it is not yet understood why an activated steel cathode did not corrode in an undivided cell in 30% caustic. Over 2 years of operation there was no evidence of corrosion of the cathode structure.

## 6. Coating corrosion

The activity of the electrode coatings is, of course, an important aspect of the chloralkali process, since it directly influences the power consumption of the process, which stands for roughly 50% of the production costs. Since more than 80% of the worldwide cellroom capacity is equipped with metal anodes, let us first focus on noble metal oxide coatings.

These are mostly based on  $\text{RuO}_2/\text{TiO}_2$  mixtures containing about 30%  $\text{RuO}_2$ . The stability of the coating is related to the almost identical lattice parameters of rutile and  $\text{RuO}_2$ . Several investigations have been made dealing with the activity of the coating and its deactivation mechanisms. It is assumed that Ru compounds of various oxidation states participate in the chlorine evolution as well as in the corrosion process. The presence of  $\text{RuO}_4$  in the chlorine gas and the sensitivity of the coating against oxygen evolution supports this theory.

Basically these laboratory data are correct, but they are of minor importance for the industrial chloralkali process. In a mercury cellroom the contact with the amalgam cathode, which will deactivate the anode by local overheating and/or chemical attack of the amalgam, is more important.

Curve a in Fig. 4 shows the dependency of the cell voltage and the equivalent  $k$  factor on the width of the electrode gap at  $12 \text{ kA m}^{-2}$ . The cell voltage becomes lowered by the decreased electrolyte resistivity. The slope of the straight line represents the specific resistivity of the electrolyte and indicates that the bubble

effect can be neglected. At a distinct electrode gap the slope of the line is more than doubled. Now the chlorine-rich zone next to the anode is touching the amalgam. According to the Bruggemen equation the gas content of this zone is about 60–70%.

The simultaneously measured amalgam concentration (curve b in Fig. 4) drops from 0.19 to 0.15%, corresponding to a decrease of the current efficiency by some 20%. The optimum cell voltage at this current density is obviously about 4.12 V. To achieve this voltage the gap must be maintained at about 1 mm across the total cell area of up to  $40 \text{ m}^2$ . Computer-controlled anode adjustment provides an even current distribution at the preset  $k$ -value but the 'tickling' of the mercury cannot be avoided. 'Tickling' implies a brief contact of the amalgam with the anode due to uneven mercury flow conditions.

Figure 5 shows the influence of the current density and the  $k$ -value on the lifetime of the coating expressed as percentage of the cellroom to be reactivated per year. 100% stands for one year lifetime, 50% for two years and so on. The current density is believed to be a measure of the co-evolved oxygen, the  $k$ -factor represents the deactivation by 'tickling'. The higher the current density and the lower the  $k$ -value, the lower the lifetime will be. It can be seen that there is a good correlation of all cellrooms under investigation.

The data for manually operated cellrooms are more scattered; the cell performance can, of course, not be kept at the highly uniform level of computer controlled cellrooms.

To prevent damage by mercury 'tickling' or even by short circuits, several coatings were developed which limit the local current. For instance, an intermediate layer of substoichiometric  $\text{TiO}_x$ , where  $1.95 < x < 2$ , limits the current because this sublayer is oxidised at the spots of local high current densities by conversion to  $\text{TiO}_2$ .

Diaphragm and membrane cellrooms face higher oxygen levels, which may mean higher corrosion rates. But because of the lower current densities the service

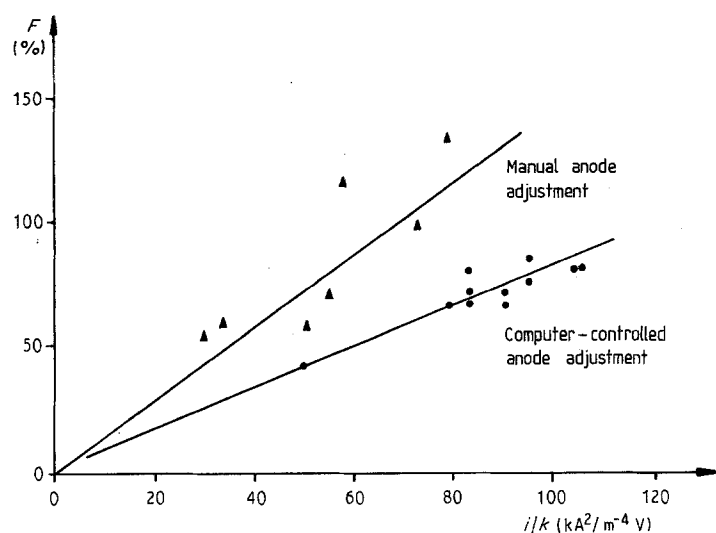

Fig. 5. Lifetime of anode coatings in Hg cells vs the ratio current density/ $k$  value,  $i/k$  ( $\text{kA}^2 \text{Vm}^{-4}$ ).

life is higher than in mercury cells and may exceed 8 years. Over this long time another process may become important; the formation of a passive sub-layer formed by the titanium substrate. In principle this layer will act in the same way as the substoichiometric layer at high current densities, i.e. it will increase the cell voltage.

Today, two countermeasures have been introduced industrially. The replacement of part of the Ru by Ir or Pt increases the oxygen overvoltage significantly. This modification of the coating composition lowers the oxygen content of the chlorine facilitating the direct use of the chlorine in oxygen sensitive reactions and it modifies the doping of the intermediate  $\text{TiO}_2$  layer, thus decreasing the field strength across the layer. Therefore the growth of the passive layer by the high field mechanism is prevented. In membrane cell-rooms, the effect may be enhanced by acidification of the feed brine to such an extent that all back-migrating caustic is neutralized.

Activated cathodes can only be inserted in membrane cells. Diaphragm cells depend on mild steel which cannot be activated as was outlined earlier, the announcement of a successful start-up of a coating facility for diaphragm cathodes some years ago was withdrawn later.

Several coatings have been developed for membrane cells, which basically may be divided into three groups: (1) metallic noble metal activation; (2) noble metal oxide activation; (3) Raney metal activation. First trials with Pt activation exhibited high corrosion rates of these coatings due to hydride formation. The noble metal flaked off the structure because of the mechanical stress introduced by the incorporation of hydrogen. Today there are some coatings based on fuel cell technology available; the noble metal is fixed on an active carbon matrix, which in turn is applied to the electrode structure. Some Japanese companies report a successful operation of these coatings.

Several attempts have been made to make use of the same coating materials as used for chlorine evolution. Basically the hydrogen evolution is catalysed by  $\text{RuO}_2$  [6–10], but the current density is limited because of the corrosion at high current density. Obviously the

increased  $\text{OH}^-$  concentration in the Helmholtz layer causes the formation of ruthenate ions. To stabilize the  $\text{RuO}_2$  coating, it is embedded in a matrix of NiO [6–8], or it is stabilized with PtO [9] or Ir [10]. The initial overvoltage of this coating is about 50 mV at  $3 \text{ kA m}^{-2}$  in laboratory cells, which means a significant reduction of the cell voltage. However, in industrial cells, the overvoltages are 100–150 mV.

The most active industrial coatings are still based on Raney alloys, mostly Raney-Ni is used. At  $3 \text{ kA m}^{-2}$  the overvoltage of industrially produced coatings is 70–90 mV. Special coatings may reduce the overvoltage to 50 mV. The main advantage of Raney-Ni is that it will not corrode, but deactivation is caused by a recrystallization process, which proceeds for years. Eventually an extremely rough Ni surface is formed, the overvoltage of which is still about 200 mV below that of a non-activated Ni cathode.

These differences of the coating activities may seem to be small and of no special interest. To demonstrate the different power costs the following example compares two coatings to be installed in a cellroom of 500 tpd NaOH capacity.

Figure 6 exhibits the stability of a noble metal oxide coating and a Raney-Ni coating; the considered service life is 6 years. The overvoltage of the oxide coating increases from the very beginning because of the slow but steady corrosion of the noble metal oxide as well as poisoning of the catalyst surface by adsorption of impurities. The activity of the coating is directly related to the catalyst loading and the actual surface available for the hydrogen evolution reaction. Eventually, the cathode exhibits the overpotential of smooth Ni.

Raney-Ni exhibits a constant cathode potential for about two years, then the recrystallization process causes an increase of the potential, which finally reaches the potential of an extremely rough Ni surface, which is stable [11]. In principle, poisoning yields the same effects, but since the adsorption takes place at the surface layer of the catalyst the actually working area is only slightly reduced. For example, the uptake of about  $20 \text{ g m}^{-2}$  Hg caused an increase of the cathode potential by 300 mV — at this load any smooth cathode would behave just as a mercury electrode.

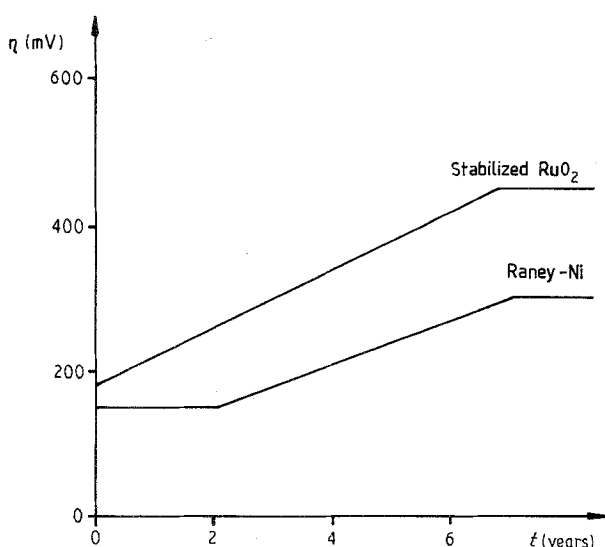

Fig. 6. Energy savings with different cathode activations.

Both diagrams are somewhat schematically drawn, because only the key figures, start potential, average slope and final potential, may be compared. Assuming full load over the 6 years, the difference in the energy consumption would amount to 120 000 MWh corresponding to 12 million DM difference in energy costs.

## 7. FRP corrosion in caustic solutions

An example of the failure of non-metallic materials in chloralkali cellrooms will be discussed.

Which material should be used for the caustic header in membrane cellrooms? In mercury or diaphragm cells there is a current breaker installed, which minimizes the stray currents through the cellroom headers. This is possible because only the product caustic or cell liquor leaves the cell.

In membrane cells, the caustic is circulated in order to get a more uniform distribution of the caustic concentration across the cathode frames and to guarantee a proper dosing of the soft water added to the feed caustic. A membrane cell roughly circulates ten times more caustic volume than is discharged from a mercury cell of the same capacity. This means a simple current interruptor, which is nothing more than a device providing a dropwise discharge of the caustic, will not work. In addition, the feed pipe, where no interruptor can be installed, must be protected. Therefore, stainless steel or nickel pipes cannot be installed in general because the handling of the stray currents, as was presented for chlorate electrolysis, is limited to small cellrooms. Transpassive corrosion will occur at potentials far lower than the potential drops caused by the stray currents passing through the caustic. For this reason fibre-reinforced plastic (FRP) pipes are normally used. There are some resins available which are caustic resistant because of their special composition. Widely used in Deracane 411, which is a vinyl-ester resin basically containing Bisphenol A as the alcoholic component and acrylic acid as the vinylene component. The cross linking is done by

styrene. In a caustic environment FRP pipes can be used at up to 100°C. For a special cellroom the lifetime of the pipes was guaranteed to be 6 years and was expected to exceed 8 years.

First leakages occurred after 2 years operation; the inspection of the header walls exhibited severe corrosion of the entire system. First investigations were misled by the analysis of high chloride levels in the corrosion product, which were explained by the presence of active chlorine in the caustic system; Deracane resin is extremely sensitive to oxidizing agents.

It took some time and comparison of spare materials of the original supply, to exclude this corrosion mechanism. Spares laminated with the same resin on site withstood the attack of the caustic; the original components did not. The inspection of unused spare parts finally proved an ordinary fabrication failure to be the source of the trouble.

The pipes were not heat treated after the fabrication process, i.e. the cross linking by styrene was not sufficient. The analysis exhibited the fourfold residual styrene concentration as specified by the resin supplier. Differential thermoanalysis showed reactions in the range 80 to 85°C which disappeared after heat treatment.

Another mistake was made in formation of the inner corrosion layer. In a caustic environment, this must be built up with synthetic veils instead of glass veils to assure a complete sealing of the inner surface by the resin. In this case the manufacturer used standard glass veils. Due to an improper application of the resin air bubbles were included causing a poor adherence of the resin to the glass matrix. These are, of course, ideal conditions for the caustic to creep into the wall and to dissolve first the glass matrix and, later, to attack the resin.

This example demonstrates one important factor for a successful plant operation which cannot be determined in a laboratory; the uniform quality of the materials. Normally it should not be a problem to supply several tons of metallic equipment of a uniform material quality, but the proper production of several tons of synthetic equipment may cause some quality problems.

## References

- [1] M. Pourbaix, 'Atlas of Electrochemical Equilibria in Aqueous Solutions', Pergamon, New York (1966).
- [2] P. Kohl, unpublished results (1982).
- [3] K. J. Vetter, 'Electrochemical Kinetics', Academic Press, New York (1967).
- [4] P. Kohl, unpublished results (1982).
- [5] A. D. Davydov and O. V. Zemskova, *Electrokhimiya* **22** (1986) 1050.
- [6] DOS DE 33 44 416.
- [7] DOS DE 33 22 169.
- [8] EP 0 240 413.
- [9] D. E. Grove, in 'Modern Chloralkali Technology', Vol. 3, Ellis Horwood, Chichester (1986).
- [10] DOS DE 29 05 180.
- [11] M. Seko *et al.* Recent developments in electrochemical engineering for application of ion exchange membranes, 34. ISE meeting 1983, Erlangen.